

CALLING ALL MAKERS!

DIY  
HOUSING  
ACCESSORIES FOR  
ANIMAL SHELTERS

ALL YOU NEED TO KNOW TO **MAKE** YOUR  
SHELTER'S HOUSING MORE HUMANE

---

KORET SHELTER MEDICINE PROGRAM

*Everything you need for animal  
shelter housing accessories is here  
in DIY fashion.*

*We had fun making these and we  
know you will too!*





## FELINE HOUSING ACCESSORIES

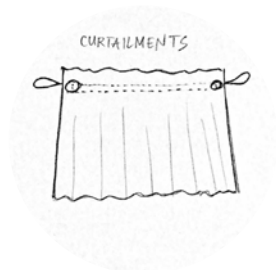

### **Curtailments**

Some privacy, please?  
I just need a little break  
To be my best self

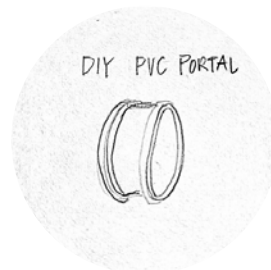

### **PVC Portals**

I love my portal  
Adopters will fall in love  
Now I can woo them

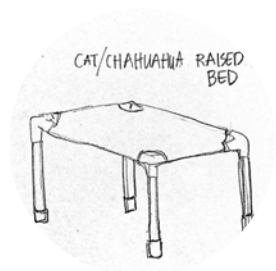

### **Raised Beds**

Up on my raised bed  
Down below my hidey-hole  
Raised bed, happy cat!

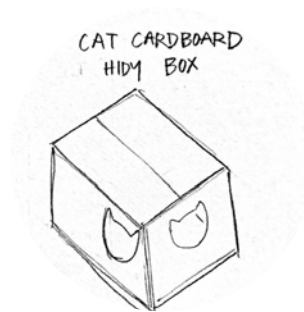

### **Hidey Box**

Peek-a-boo kitty!  
For sleeping, hiding, or play--  
Forts aren't just for kids!



### **Cat Toys**

No not the wrapper  
No not the milk cap. The toy!!!  
Fine, have some paper

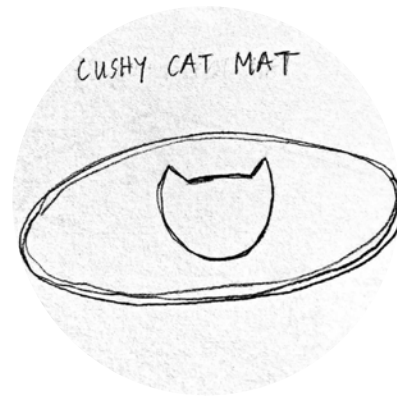

### **Cushy Cat Mat**

Kermit and Piggy,  
Peanutbutter and jelly,  
Raised bed and cat mat

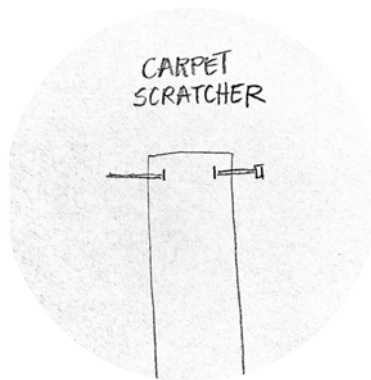

### **Scratchers**

Carpet and zip ties  
all you really need to give  
kitties room to  
strrrrreeeecccchhhh

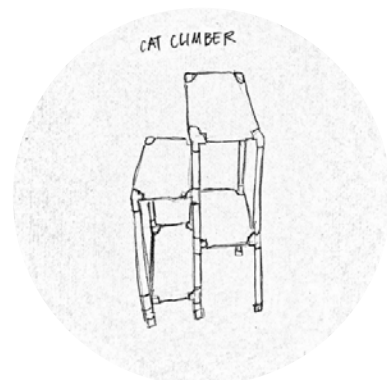

### **Climbing tower**

Rapunzel kitty  
Climbing your tower, nurture  
Curiosity



GREAT ONE-TIME  
VOLUNTEER OPPORTUNITY!

## Curtailments

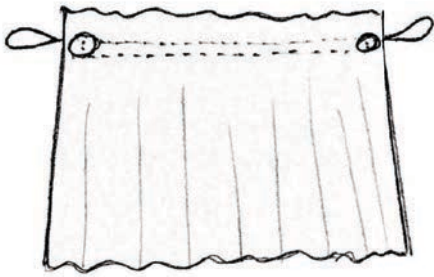

Cost: Couple bucks

Time: 30 mins

Skill Level: Basic sewing knowledge

We know, curtailments seem a little "cutesy". But don't be fooled, they are as effective as they are fun. Would you want to stay in a hotel that had no room doors or shower curtains? We all want a little privacy, especially when we are someplace new.

### News to No One: Cats like to have a choice.

Giving cats the ability to retreat helps relieve fear and stress. Lowering stress can mean the difference between a healthy cat and a sick cat. A simple curtain on a cage door or on a raised bed can help provide visual choice and retreat space.

## Materials

- 1 yard of fabric (45" wide): cotton is easy to work with, but any material will do (second hand sheets, old dresses, muumuus, etc.)
- $\frac{1}{4}$ " or  $\frac{3}{8}$ " flat elastic (either will work). You'll need close to a foot.
- Round elastic cord ~18"
- Two buttons ( $\frac{3}{4}$ " to 1" work well)
- Scissors
- Sewing machine
- Tape measure

### Types of Curtailments

- Castle Door: fits under a raised bed (homemade or Kuranda)
- Partial Cage door cover: fits on a 2x2 cage door

### Directions for both curtailment types (we recommend reading through before starting a curtailment project)

1. **Cut.** Cut 1 yard of 45" wide fabric into 4 rectangles of about 18" by 22.5". One yard of material will make 4 curtailments this size.
2. **Hem.** Hem all raw edges. For each single curtain, fold under the edges of the fabric  $\frac{1}{4}$ " then again  $\frac{1}{4}$ " so no raw edges can be seen along interior edge of fold.



## Curtailments cont.

3. **Create a sleeve** for the elastic by folding over the top edge. See below for each curtailment type.

- 2x2: Fold over the top edge (one of the 18" sides) 1.5".
- Castle Door: Fold over the top edge (one of the 22.5" sides) 2.5".

**For both:** Sew a line of stitching at the edge of the material (away from the fold). Sew a second line of stitching  $\frac{1}{2}$ " away from the first. This will be the sleeve for the elastic.



### *For Castle Door only*

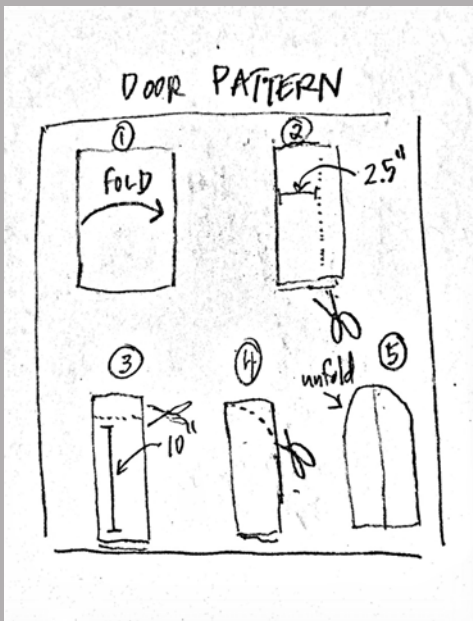

### **Make the door**

- Make a pattern out of paper using the Door Pattern to the left. Fold an 8"x11" piece of paper lengthwise. Measure 2.5 inches in from the folded edge and make a line that runs parallel to the fold the length of the paper. Cut along the line.
- Cut length to 10 inches.
- Round the corner on one end of the folded paper—away from the folded edge. Pro tip: Use a cup to help draw the curve.
- Open the pattern and pin in place about 3.5" from one side or the other with the bottom of the pattern along the lower edge of the curtailment.
- Cut out the door and hem the raw edges as done previously. Take your time around the curved part of the door.

4. **Cut the elastic.** Use  $\frac{1}{4}$ " or  $\frac{3}{8}$ " flat elastic. Cut a piece: 8" long for the 2x2 partial door curtailment or 11" long for the Castle Door curtailments.

## Curtailments cont.

5. **Pull the elastic through the  $\frac{1}{2}$ " sleeve made in the top of the curtailment.** Use large safety pin to attach and then work the elastic through the sleeve. (Note: Be careful not to pull elastic completely through the sleeve. When the opposite end of the elastic piece nears the edge of the curtailment, sew it in place – see step 6 – then continue to work the elastic to the opposite edge.)

6. **Sew the elastic in place.** At  $\sim \frac{3}{4}$ " (pic 6a) inwards from the edge sew up and down over the elastic held inside the sleeve (go over it a few times so it will not pull loose). You will leave a little pocket at the edge for later (pic 6b). Do this for both sleeve ends.

7. **Cut elastic.** Cut rolled elastic cord to two 9" lengths. Then:

- Fold cord in half and tie both ends into a single knot (pic 7).
- Slip the knotted end of elastic into the pocket made in step 7, pushing the knot further into the pocket so you do not have to run over knot when sewing the edges.

8. **Sew elastic in place.** Sew over the open edge of the pocket making sure to catch both sides of the material along with the elastic cord.

9. **Button time!** On the front side of the curtain sew a button to each end of the  $\frac{1}{2}$ " sleeve- slightly inside the hemmed edge so as not to have to sew through the knot of the elastic cord



# Raised cat bed

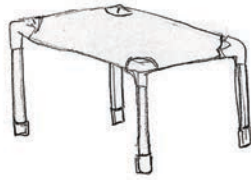

Time: About an hour

Time: \$20

Skill Level: Medium

When space is at a premium, you can keep cats healthy and comfortable by opening up usable floor space with a raised bed. The top bunk is for lounging (the better for adopters to see you, My Dear) while the space underneath provides a place to retreat when cats need a little break.

The finished product measures approximately 20" long, 14" deep and 14" high. It will fit into a standard 2' x 2' or larger cage. Measure the inside dimensions of your cage to ensure the bed will fit. Adjustments can be made easily by changing the dimensions of your bed to fit the size cage you have. Maximize the length of the bed when you can and try not to make it much skinnier as cats need space to lie comfortably.

## Materials

- Sharpie pen
- Scissors
- Paper towels
- Old tablecloth (to protect surfaces)
- Saw to cut the PVC
- PPE - safety glasses, hearing protection, gloves
- Four 1" end caps
- 1, 10 foot, 1" PVC
- 4 - 3 way PVC fittings (Furniture grade PVC fittings are fine.)
- H66 glue for vinyl
- Clear PVC glue
- One yard of 18 oz vinyl coated fabric

### Making the bed frame:

1. **Cut the PVC** to the following lengths:

2 pieces: 11 ½" (ends)

4 pieces: 12 ½" (legs)

2 pieces: 17 ½" (sides)

2. **Glue.** Glue one 12 ½" leg into each of the 3-way fittings.

3. **Assemble the bed frame.** No need to glue further unless you want to—but don't do it quite yet. When attached, the vinyl bed will keep the frame together.

4. **Add the end caps.** Attach 1" end caps to the leg ends.

5. **Check your work.** Try out the bed frame in your cage. Make sure it fits before gluing or adding the vinyl or making a bunch more—if it's a tight fit, take a little (1/4" or so) off each of the 17 ½" PVC pieces until the bed fits.

**If you want to glue the frame do it at this time.** To prevent wobbling, make sure the bed frame will sit squarely on a flat surface before you glue. The PVC glue sets very quickly.



## Raised cat bed cont.

### Making the vinyl bed:

1. **Make a template.** Use this drawing to make a pattern that can be traced onto the vinyl fabric.

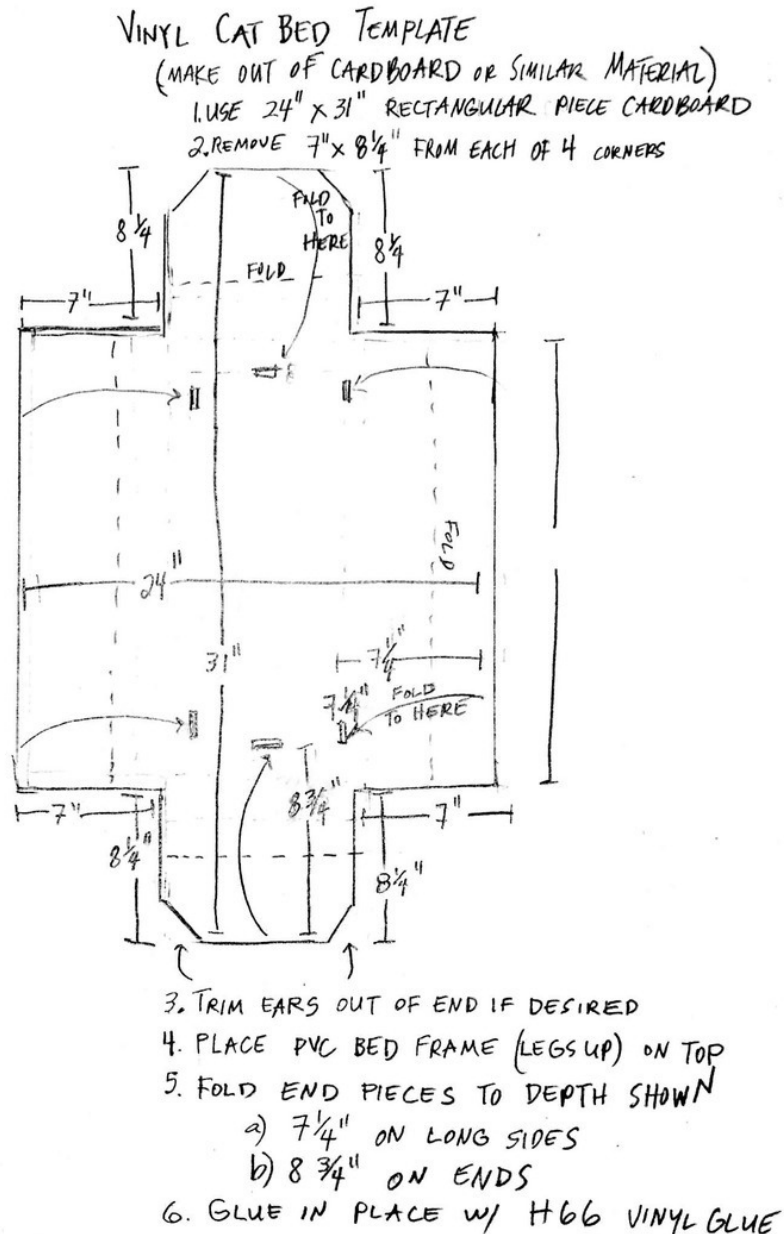

2. **Cut out a bed.** Lay the vinyl fabric flat with the rough side up and trace the pattern. Mark with a Sharpie where the folded sides will be glued. On the long side this will be at ~7.25" from the edge and on the ends this will be at ~8.75" from the end. Cut out the bed.



## Raised cat bed cont.

### Attaching the vinyl bed to the frame.

1. **Place the PVC frame upside-down onto the cut out vinyl bed.** Some vinyls have a smooth side and a rough side. Keep the smooth side for the top and the rougher side for the bottom of the bed.

2. **Begin to glue flaps.** Easiest to do one flap at a time. Place a  $\frac{3}{4}$ " wide strip of H66 glue along the entire edge of the vinyl flap piece to be folded over. Fold flap over the pipe and line up with Sharpie marks. Try not to get glue on the PVC pipe. If you do, wipe it off with paper towel before folding over the vinyl flap. Glue takes about 60 seconds to begin to grab hold. Use your fingers to hold vinyl flap in place while it dries. Rub over the entire glued surface to keep glue in contact with the vinyl surfaces. After about 1-2 minutes glue will hold on its own and the next vinyl flap can be glued.

3. **Check your work.** When fully glued, check all previously glued sides. Place a little pressure on the glued area to ensure pieces are sticking together, then set bed aside. Note: If you find after about 30 minutes that an edge didn't hold well, take the time to re-glue it. This will ensure long life...of the bed.

Wait a day for the glue to fully cure before you put to use.

**p.s.**

Additional bedding should be provided (see Cushy Cat Mat) to the top of the beds to provide warmth and comfort.

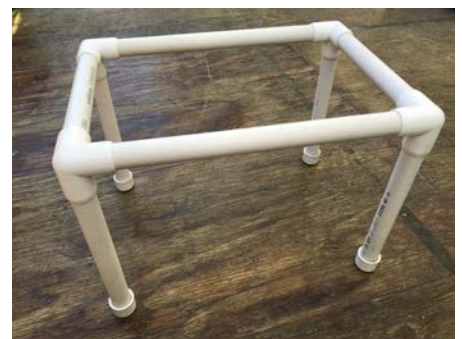

# Cat climbing tower

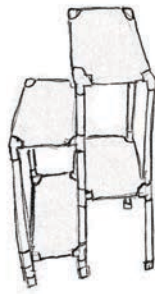

Cost: \$75.00

Time: 2 Hours

Skill Level: Medium to hard

Looking for a building challenge or an opportunity to show off your crafty skills? Give the climbing tower a try! These are fun to build and provide four levels of glorious wild kitty antics, sleepy spots, plus they just look so dang cool! Up for the challenge? Don't forget to send photos of your tower to us at [sheltermedicine@ucdavis.edu](mailto:sheltermedicine@ucdavis.edu)

## Materials

- Saw to cut the PVC
  - Clear PVC glue
  - PVC pipe and fittings: See breakdown below
  - 2 yards of 18 oz vinyl coated fabric
  - Heavy duty scissors
  - Sharpie pen
  - Paper towel
  - Mallet
  - H66 glue for vinyl material
- **Fittings:** All fittings are for 1" PVC pipe (furniture grade is fine).
    - 6, 3-way
    - 10, 4 way
    - 6, end caps
  - **PVC Pipe:** 4, 1" PVC pipe 10' long.

PVC pipe can be found at home improvement stores in the plumbing section (these are generally 10 feet long).



*Pro Tip: Read through instructions completely before making this - it helps to reduce mistakes on this one.*

### Directions:

#### Cut 1" PVC pipe.

Note: Mark each piece with its length near one end or the other of the pipe (the marking will get covered by the fittings if it is within about 1" of either end).

4 pieces 11.25"  
6 pieces 10.5"  
4 pieces 22.5"  
2 pieces 23.25"  
8 pieces 17.5"  
8 pieces 11.5"

## Cat climbing tower cont.

**Cut out vinyl for the beds.** Use the bed pattern included in the Raised Cat Bed instructions.

Cut out 4 beds from vinyl coated fabric.

**Assemble the bed frames.** Use the 11.5" and 17.5" pieces and the fittings for all four beds. (11.5" for the ends and 17.5" for the sides).



The fittings differ for several of the beds (see diagram on the next page):

- Top bed will have 3-way fittings at all four corners
- Third bed will have two 3-way fittings and two 4-way fittings
- The two lower bed will have 4-way fittings at all four corners



**Assemble the rest of the structure.** Putting it together loosely will help to identify how beds/fittings/pipe will go together for assembly. Use the Assembly Guide drawing on the next page to help assemble.

**Disassemble the structure.** Keep like lengths together for reassembly. **Keep beds intact.**



*Tempted to skip this step aren't you? Don't! Promise I wouldn't have had you do this if it wasn't a huge time saver in the end. "Measure twice, cut once," is dang good advice that I have learned the hard way myself.*

**Add vinyl to the bed frames.** See Raised Bed instructions to make all four beds.



## Cat climbing tower cont.

**Final Assembly:** It's easiest to build and glue the tower from the bottom up. Use the Assembly Guide drawing below to reconstruct the tower.

Ensure the PVC pipe seats fully into the fittings. A mallet may be helpful to have handy for any stubborn connections. PVC glue dries very fast so make adjustments quickly.

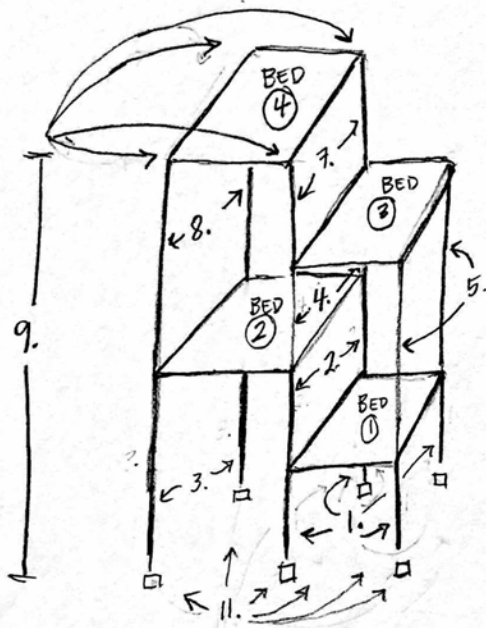

Bed ① + ② Have 4 way fittings at corner  
 Bed ③ has 2, 4 way fittings & 2, 3 way fitting  
 Bed ④ has 3 way fittings at corners

### ASSEMBLE STRUCTURE W/PVC GLUE

1. Add 11.25" legs to Bed ①
2. Add 10.5" pieces
3. Add 23.25" pieces to Bed ②, the attach to top of 2.
4. Add 10.5" pieces
5. Add 22.5" pieces
6. Add Bed ③
7. Add 10.5" pieces
8. Add 22.5" pieces to Bed ②
9. Measure distance from floor to top of all four corners. Cut off any excess
10. Add Bed ④
11. Add 1" CAPS TO LEGS □

# Cushy cat mat



Time: 20 minutes

Cost: \$10

Skill Level: Basic sewing knowledge

Designed specifically to accompany the raised bed (either atop or underneath) this gem is easy to make, easy to clean, and the ultimate in shelter comfort. Plus it's just ridiculously cute. Nothing has paired better since wine and cheese.

## Materials

- 1 yard of Polar fleece
- 1/2 yard of 1" polyester batting
- pins
- sewing machine
- scissors
- 21" x 14" piece of newspaper

1. **Make a bed pattern out of newspaper.** Take a piece of newspaper or other 21" x 14" rectangular shaped paper, fold it in half and then in half again. On the edge that has all four corners of the paper free, round the edges off with a scissors to get the round shape of the bed.
2. **Cut the fabric.** Pin the pattern you just made to the Polar fleece and cut 2 pieces.
3. **Cut the batting.** Using the pattern again, cut 1 piece from the 1" polyester batting. Then trim off an extra 1/4" from the batting edge all the way around to make it a little smaller than the pattern.
4. **Sew fabric together.** Place two pieces of fleece on top of each other with right sides together (the sides you want to face outward should be touching) and sew around the edges with a 1/4" seam. Leave a 10" section open.
5. **Turn the bed right side out.**
6. **Insert the batting.** Insert the batting through the open edge. Gently lay the batting inside the bed, making sure that it is smooth and free of wrinkles.
7. **Sew it shut.** Fold under the edge at the opening, pin to hold in place, and sew over. Sew close enough to the edge to catch both edges. Continue to sew around the edge of the entire bed.
8. **Make a design.** Simply stitch the center of the bed with a shape of a cat head (see template) or cut the cat head out of a separate piece of polar fleece and sew along its edge in the center of the bed. This will help to keep the batting in place as it's used and washed.

**Voila!**



# Cushy cat mat template



*Fun fact: This template is made from an actual portal hole cutout*

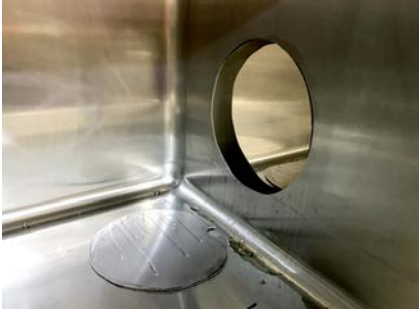

# Hidey Box

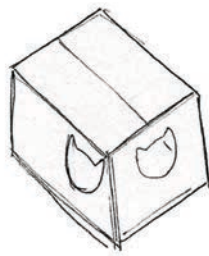

Time: 10 minutes

Cost: \$2

Skill Level: Easy

It's hard to imagine a greater love than cats have for boxes. We may never figure out the mystery of that great love affair, but who are we to hold 'em back? For an extremely quick, easy, and inexpensive crafty project, check out the Cat Hidey Box!

## Materials

- Small heavy duty cardboard box 16 inches long x 12 inches wide x 13 inches tall (this one is from Home Depot)
- Sharp knife with 4"-6" blade
- Sharpie pen
- Tape

1. **Keep box flat.** Lay the small, heavy duty cardboard box flat on the ground.
2. **Get your template ready.** Take the cat silhouette template (used in the Cushy Cat Mat) and lay it on the side that will be the end of the box (it's the 12 x 13 inch side).
3. **Trace the template.** Place the template at about 4" above the bottom of the box. (When done this will allow for a cozy box the cat can step into.)
4. **Cut out the shape.** Once it is traced onto the end take a sharp knife that is about 4-6 inches long to **cut through both the end and the side of the box walls at the same time.** Go slow and be careful.
5. **Tape the box.** Tape the top and bottom. Add bedding inside and it's ready to use.

**Voila! you have a Hidey Box!**



# Carpet scratcher



Time: 10 minutes

Cost: \$1

Skill Level: Easy

Cats have a natural desire to scratch and stretch. Scratching helps cats remove the dead outer layer of their claws while stretching keeps cats physically fit and mentally healthy. Keep the cats in your care happy and stimulated by providing a carpet scratcher to hang on the cage door. These are fun and easy to make, and you'll receive a hearty thank you, the first time a kitty streeeeeeetches out and scratches your handiwork.

## Materials

- Carpet remnants, or new stiff-backed throw rug
- Carpet knife (be careful now, these are sharp)
- Long piece of wood to cut upon
- Second piece of wood that is the width of your chosen scratcher (2 x 4 makes a 3.5" scratcher)
- Three 8"-12" zip ties per scratcher (if wider scratcher get wider zips)

Make scratchers 3.5" to 5" wide and about 18" tall to fit 2x2 cage doors (pic 3).

### Directions:

1. **Prepare for cutting.** Place the carpet face down onto the board used for cutting upon. Use a second board (the one that is the width of your chosen scratcher) and lay it on top of the carpet (pic 1).
2. **Line up the edges of the board and carpet.** Cut along the scratcher board edge through the carpet down to the cutting board. Voila! you have a nice carpet strip of the desired width.
3. **Cut the carpet strips.** Cut the carpet strips into 18" lengths and your carpet scratchers are nearly made.
4. **Zip! Zip!** On either end of the strip of carpet add a zip tie by using the carpet knife to make a couple small slits in the back of the carpet so you can slide a zip tie through. Orient the zip tie such that it can be easily closed when hung on the cage door.
5. **Attach.** When attaching these to the cage door, take an extra zip tie to attach the scratcher to the upper bar of the door—so it won't slide down when the cat scratches on it.

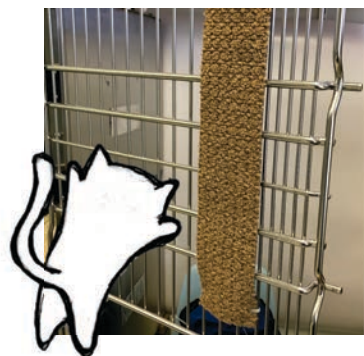
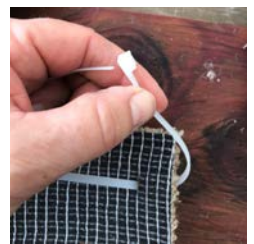



# Cardboard Scratcher

Time: 10 minutes

Cost: \$1

Skill Level: Easy

Thanks Indiana Humane, these are supa fun!

Cats have a natural desire to scratch and stretch. Scratching helps cats remove the dead outer layer of their claws while stretching keeps cats physically fit and mentally healthy. Keep the cats in your care happy and stimulated by providing a cardboard scratcher to hang on the cage door. These are fun and easy to make, and you'll receive a hearty thank you, the first time a kitty streeeeeeetches out and scratches your handiwork.

## Materials

- Box cutters
- Scissors
- Cardboard
- Non-toxic glue
- Catnip

1. **Cut the cardboard.** Cut about 25-30 pieces of cardboard for each scratcher you intend to make. The thinner the cardboard, the easier to cut; although you'll need more pieces the thinner it is.

Pieces should be approximately 1-2 inches wide and 8 inches long—it is most efficient to make the initial cuts with box cutters and then follow the lines to make final cuts with scissors.

2. **Glue the cardboard.** After all the pieces have been cut, use non-toxic glue to glue pieces together. Glue pieces so they are stacked on top of each other.

3. **Dry.** Let dry overnight.

4. **Choose delivery method.** Hanging or freestanding? See below.

5. **Spice it up.** Sprinkle catnip on the completed cat scratcher.

6. **Live it up.** Give to cat to enjoy!

**Freestanding:** You may use a shoe box cover or any piece of cardboard to act as your base. Simply follow all the above steps, but on Step 2 you will also need to glue the side of your scratcher to your base.

**Hanging:** Without a base, you may use a zip-tie to hang the scratcher to a cage door. Glue a small square of cardboard ( $\frac{1}{2}$  inch by  $\frac{1}{2}$  inch) to the top and bottom of the scratcher diagonally (so the top piece is off-center to the left and the bottom piece is off-center to the right). Once the glue is dry, use a hole puncher so you can tie the scratcher to a cage door.



# Easy peasy cat toys

## Magic Noodle Wand

SF SPCA, these are awesome! Thank you!

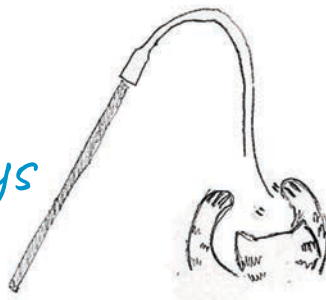

*Fun Fact: Did you know just seeing toys in a housing unit increases adoptability, even if an animal isn't playing with them at that moment?*

Attach a "noodle" to a dowel and watch cats go crazy! Give your feline friend a great workout by guiding them up and down their tower or through their portal hole before letting them have "the kill." These noodles are easy to sanitize by soaking in a Rescue® solution (a big mesh bag helps keep noodles together while soaking) so you can use them over and over.

## Materials

- Dowel
- Eyeglass retainer
- Otoscope tip

### The wooden dowels are from:

Atlas Dowel

1-513-202-9444

[www.atlasdowel.com](http://www.atlasdowel.com)

Recommended sizes: 1/4 x 12" and 1/4 X 24" (shorter for cage play, longer when you are in a kennel/condo). Prices range from .10 to .20 each.

### To purchase the "cat noodle" (really eyeglass/sunglass retainers):

NECKZ Eyewear 1-866-779-7800

Joan: [joan@neckz.com](mailto:joan@neckz.com).

They are about \$1 each, after tax and come in a variety of fun colors.

Now for the real secret: How do you attach the noodle to the dowel? You could just wiggle them on, but an otoscope tip that's been cut at the very tip makes toy assembly a breeze. Great project for a volunteer working the help/welcome desk.

New adopters love to buy these, and we recommend adding a warning label that reminds guardians to "put away when not in play" so little nibblers don't sneak a bite of that noodle.

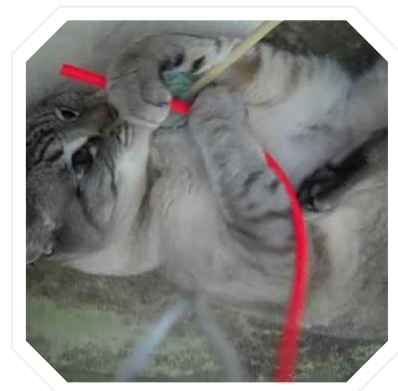

## Easy peasy cat toys cont.

Are they here yet?!

Enrich your cats' days while they pass time waiting for their new adopters. Variety is the spice of life—we all get bored with the same ol' same ol'. Think of ways you can use free materials to change up your play sessions and keep cats stimulated.

### PAPER TREAT BALLS

#### *Materials*

- Scrap Paper
- Cat Treats/Nip
- Imagination



#### **Directions:**

1. Set chosen treat on a piece of paper.
2. Crumple a piece of paper. It can be printer paper, construction paper, tissue paper, wrapping paper, origami paper...doesn't matter. Crumple it into a ball.
3. Throw it near the cat. See cat bat. See cat run.

Enjoy a desk free of paper clutter!

Photo - I took contents from my paper recycling bin and shared a tiny bit of my tuna sandwich for the middle, and that's it! 2 seconds of effort = 45 minutes of play

### PIPE CLEANER TOYS

#### *Materials*

Pipe Cleaners

#### **Directions:**

1. Wrap a pipe cleaner around your finger. Bam. Coolest spiral everrrrr (paraphrasing an actual quote from a cat).

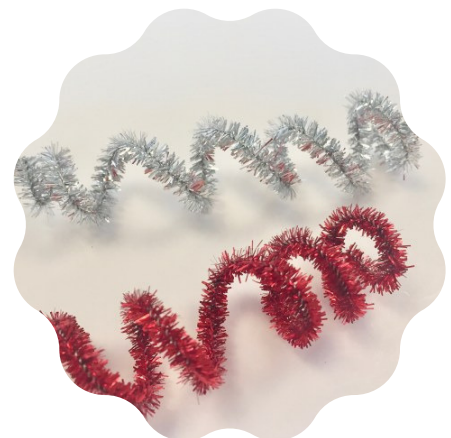

Note: New toys are fun! This toy should only be used while supervised. It'll be a special treat when it springs up during a play session, but make sure to take it with you when you leave.



## DIY PVC portal

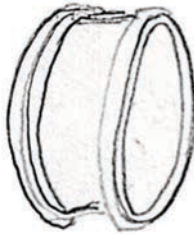

*Time: 1-2 hours*

*Cost: \$12*

*Skill Level: Kinda hard, but you've got this!*

Portals convert cramped single-compartment housing to spiffy double-compartment condos that give cats more usable floor space, allow for separation of eating and elimination areas and make cleaning time easier for cats and staff alike.

Homemade portals made out of PVC pipe work well, and are sometimes preferred when the distance between cages is unusual; however, the manufactured Kat Portals that we developed and are now made and distributed by SHOR-LINE come in three sizes: skinny, standard and wide. So nearly every cage type can now be portalized with the easy to install premade portals.

Still determined to make your own? (You know we love that!) Check out our DIY instruction sheet at [sheltermedicine.com](http://sheltermedicine.com) by searching "PVC Portal"

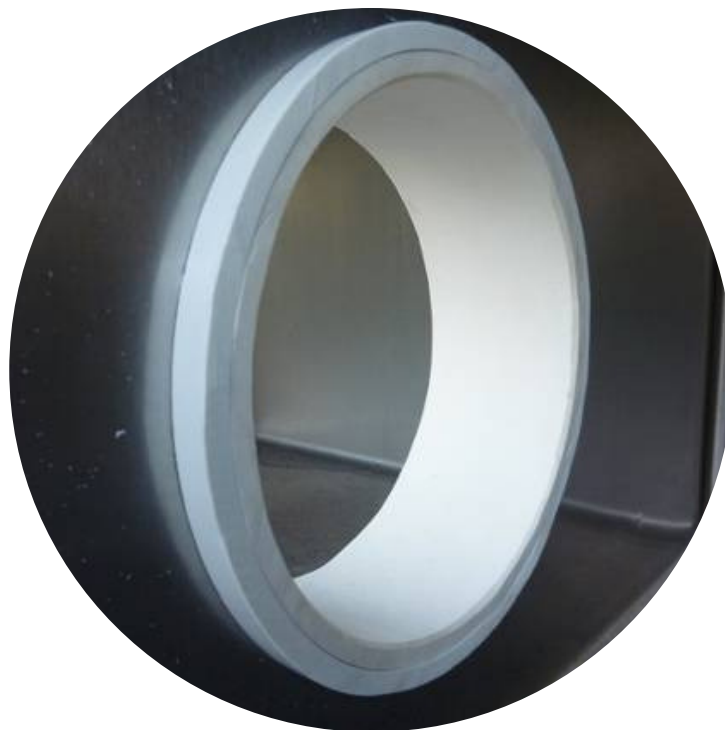

# LOW STRESS CAT HOUSING

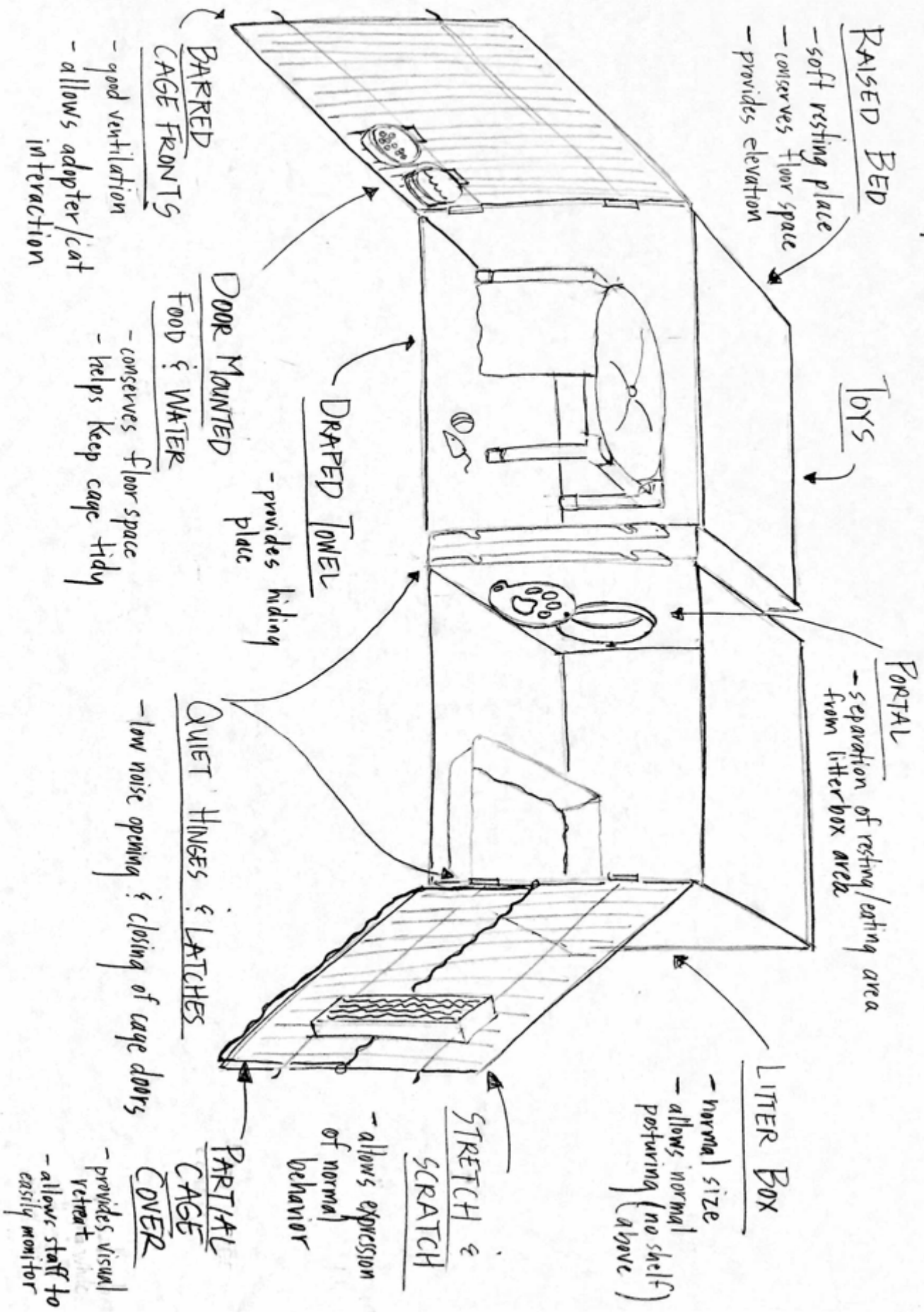



## CANINE HOUSING ACCESSORIES

\*No apologies  
For our excessive use of  
Haikus. Can't stop, won't.

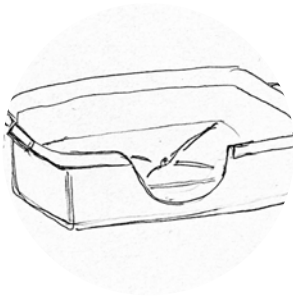

### **Dog Retreat**

Sometimes I need to  
Recharge just like the hoomans do  
I'll be with you soon



### **PVC Dog Toy**

Lots of hours in here  
Delayed gratification  
Helps my mind engage

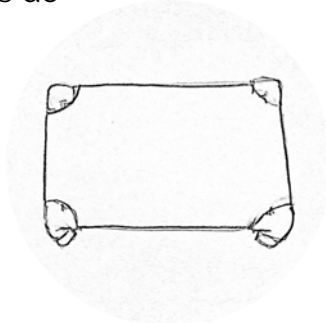

### **Dog Bed**

A dry place to sleep  
No more wet, messy blankets  
Goodnight sweet puppy

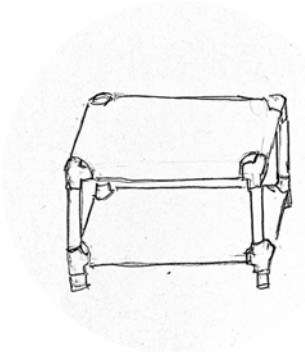

### **Dog Double Bed**

Perched on my lookout  
Or while snuggled down below  
I love my bunk bed

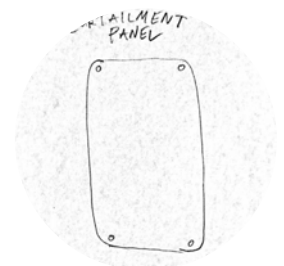

### **Dog Curtailment**

I'd like to say hi  
But I'm a bit overwhelmed  
Quiet time will help me

# Dog bed

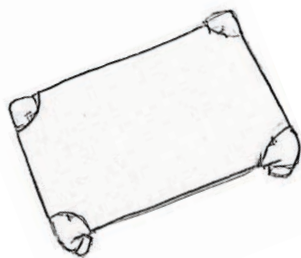

Time: 1 hr

Cost: \$30

Skill Level: Medium

Loads of laundry because a pupper tipped over his water bowl and got the bedding wet? A bed that is even just slightly off the floor does wonders for the comfort of the dogs in your care and helps keep their area tidy. This bed is perfect for pooches to snuggle up on a bit off the floor, and it will help to keep bedding clean and dry. Win-win!

The finished product measures approximately 30" long, 20" deep and sits a few inches off the ground. Adjustments can easily be made by changing the dimensions to fit your dog housing needs (read through to the end for modifications). Maximize the length of the bed when you can, and try not to make it much skinnier as dogs need space to lie comfortably.

## Materials

- 1 - 10 foot, 1.5" PVC Pipe - Schedule 40 (preferred)
- 4 - 1.5" PVC- 3 way corners (furniture grade is fine)
- 4 - 1.5" PVC Slip on end cap (optional)
- Saw to cut the PVC
- Clear PVC glue
- 1 yard of 18 oz coated vinyl
- H66 glue for the vinyl
- Sharpie pen
- Paper towel
- PPE - safety glasses, hearing protection, latex gloves
- Old tablecloth (to protect surfaces)
- Tape measure, heavy heavy duty scissors

### Making the bed frame:

1. **Cut the PVC** to the following lengths:

- 2 pieces: 16 inches long (bed width)
- 2 pieces: 26 inches long (bed length)
- 4 pieces: 3 inches long (legs)

2. **Attach the legs and glue.** Glue the 3" legs into place—one into each of the four 4 way connectors. To prevent uneven lengths, make sure to insert to their stop point inside the fitting. (Pro tip: Apply a small amount of glue up to the stop point inside the 3-way, twist the leg as it is inserted. Wipe away any excess glue.)



## Dog bed cont.

**Assemble the bed frame.** Gluing the rest of the bed is optional. Once added, the vinyl part of the bed will provide structural support. If the kennel floor is uneven, gluing is not recommended, as the bed can more easily adjust to an uneven or sloped floor.

PVC glue dries very fast. If you do want to glue everything together—because more is more!—be sure to get it squared up to the floor so the bed doesn't wobble. If not gluing, simply insert the remaining pieces to make the bed frame.



**End caps:** If desired, an end cap can be added to each foot of the bed. This is recommended but not 100% necessary. Adding end caps will help make the beds easier to clean.

### Making the vinyl bed:

1. **Make the template.** Use this drawing to make a pattern on paper or newspaper that can be traced onto vinyl fabric.

The template provided is for the 30" x 20" frame bed. If you want to make different sizes, scroll to the bottom for instructions on customizing your beds. If you are going to make more than one, do yourself a favor and make a cardboard template to make it easier to trace.

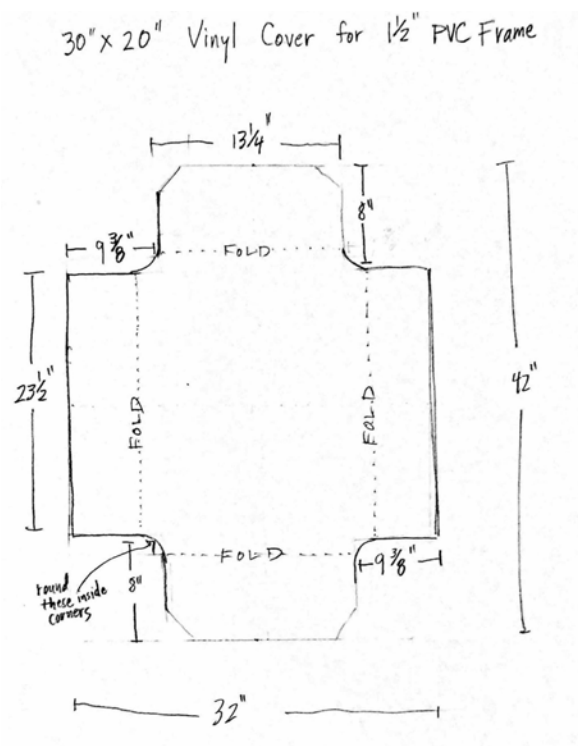

## Dog bed cont.

**2. Cut out a bed.** Lay the vinyl fabric flat with the rough side up and trace the pattern with a Sharpie. Then cut it out.



### Attaching the vinyl bed to the frame:

**1. Place the PVC frame upside down onto the cut out vinyl bed.** (Cover the workspace to protect the surface from glue drips.) Lay the vinyl material right side down (smooth side down) on the floor or work table—leave rough side facing up. Place the PVC bed frame onto the vinyl with the feet facing up. Center the frame over the vinyl bed.

**2. Begin to glue flaps.** Easiest to do one flap at a time: Apply a 1" strip of glue along the outside edge of the vinyl for the entire length. Try not to get glue onto the PVC frame—if this happens wipe it off with some paper towel. Fold the vinyl flap over the PVC towards the inside (don't make it too tight), keeping the flap parallel to the frame. Use your finger to hold flap in place while the glue dries—about 1 minute. Rub the entire glued surface to keep glue in contact with the vinyl surfaces. After about 1-2 minutes glue will hold on its own and the next vinyl flap can be glued. Repeat this for all bed sides.

**3. Check your work.** Check the previous glued flaps—look for areas that aren't holding and reapply glue and hold in place. The flaps need to be well-glued to ensure the bed will hold up for shelter use—do a fantastically good job gluing and this bed should last.

Wait a day for glue to cure fully before you put the bed to use.

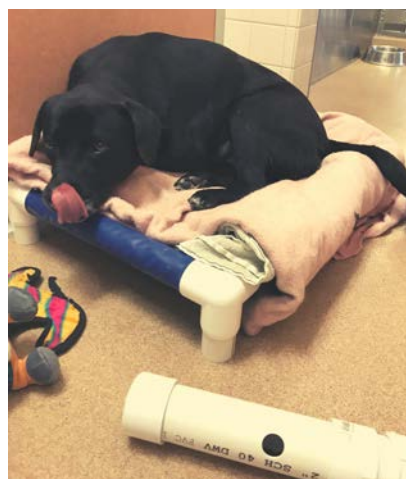



## *Dog bed cont.*



**Everyone should have a bed that's "JUST RIGHT"!**

### **Modifications:**

To make other size beds either shorten or lengthen the PVC pieces for the bed width or bed length.

If you want a 33" long bed, that is 3" longer than the current model, add 3" to the bed length PVC pieces, so  $26" + 3" = 29"$ : you will need two 29" pieces of PVC for the long side to make a 33" long bed.

If you want a 25" long bed, that is 5" shorter than this 30" bed so you would subtract 5" from the 26" length, so you would need two 21" pieces of PVC for a 25" long bed.

Same goes for any changes in the bed width. Double check your math and your bed size needs. Also if you are going to be making a number of beds...build a complete one first to make sure it is actually the size you want/need. Then go and cut your materials for the others...this will make your day of bed assembly fun and save you a trip to the store to buy additional materials...just saying—not that I have ever done this.

If you make a frame size other than 30" x 20" frame and need to adjust the vinyl bed pattern, simply add or subtract length or width to the pattern. If you make a 35" x 22" frame, add 5" to the length and 2" to the width of the pattern (do this from the center plane).

# Double decker dog bed

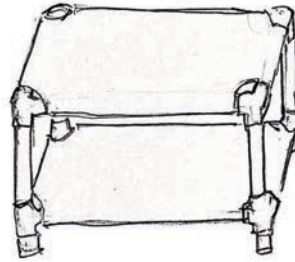

Time: 1 hr

Cost: \$65

Skill Level: Medium

A lookout perch above, or a snuggly bed below, this double decker give dogs choice while keeping blankets dry and clean. Drape a towel over the side to provide retreat space.

## Materials

### PVC Pipe:

- 3 - 1.5 inch, 10' PVC pipe

### Fittings:

- 4 - 1.5 inch 3 way fittings
- 4 - 1.5 inch 4 way fittings
- 2 yards of 18 oz coated vinyl

- PPE materials: safety glasses, hearing protection (if using power tools—or if you are working with someone talkative), latex gloves as needed for gluing, and a little common sense
- Hand saw or power saw to cut PVC
- A mallet is handy for assembly

- Tape measure
- Heavy duty scissors
- Sharpie to mark PVC and vinyl
- H66 glue
- Clear PVC glue

## Directions:

### 1. Cut PVC to the following lengths:

- 4 - pieces: 16 inches long (bed width)
- 4 - 26 inches long (bed length)
- 4 - 18 inches for the risers
- 4 - 3 inch pieces for the legs



**2. Assemble the bed frame.** Assemble the entire frame so that it is clear as to how it will fit together (pic 2). Remove the risers (the 18 inch PVC pieces) and set them aside for now so you can work with the two beds first. Make the lower bed using the 4-way fittings and make the upper bed with the 3-way fittings.





## Double decker dog bed cont.

Note: You can choose to glue the bed or not. I glue the short legs into the lower bunk, then may or may not glue the bed frames. I usually do not glue the risers so that the beds can be separated, making them easier to move and clean.

When gluing PVC fittings: cover the gluing surface inside the fitting entirely and quickly, with as little glue as possible—then assemble. If you only cover some of the fitting surface the pipe will not slide in fully. A mallet is a good backup and should be handy to ensure pipe and fittings cooperate. Don't whack it too hard or the fitting might break.

### Making the vinyl beds.

1. **Make a template.** Use the vinyl template provided in the (single stack) Dog Bed instructions above.
2. **Cut out a bed.** Lay the vinyl fabric flat with the rough side up and trace two patterns. Mark with a Sharpie where the folded sides will be glued. Cut both beds out.



### Attaching the vinyl beds to the bed frames:

1. **Place the PVC frame upside down onto the cut out vinyl bed.** Cover the table to protect the surface. Lay the vinyl material right side down (smooth side down) on the floor or work table; leave rough side facing up. Place the PVC bed frame onto the vinyl with the feet facing up. Center the frame over the vinyl bed.
2. **Begin to glue flaps.** Easiest to do one flap at a time, one bed at a time. Apply a 1" strip of glue along the outside edge of the vinyl for the entire length. Try not to get glue onto the PVC frame—if this happens wipe it off with some paper towel. Fold the vinyl flap over the PVC towards the inside (don't make it too tight); keep the flap parallel to the frame and line up with the Sharpie marks. Use your finger to hold flap in place while the glue dries—about 1 minute. Rub the entire glued surface to keep glue in contact with the vinyl surfaces. After about 1-2 minutes glue will hold on its own and the next vinyl flap can be glued. Repeat this for all bed sides. Repeat for the second bed.

## *Double decker dog bed cont.*

3. **Check your work.** Check the previously glued flaps looking for areas that aren't holding. Reapply glue and hold in place as needed.

4. **Turn the two beds into a bunk bed.** Place the bottom bed right side up, add the risers and then add the top bunk. Push together so they are nice and tight.

Note: If you need to get the beds apart, put your foot on the bottom bed frame and pull on the top one. You may need to go around the bed as you pull to loosen up, but eventually they'll come apart .



# Dog curtailment



Time: 15 mins

Cost: \$10

Skill level: Easyish

How many times have you heard this advice: Feeling stressed? Take a little break. A quick time-out can relieve stress and recharge your batteries.

Guess what? It works for animals and humans alike. Providing the option to retreat or to engage reduces stress and illness in animals in the shelter environment. We recommend no more than half (side to side) the kennel front be covered with a panel and it needs to be only 36-48" tall. The example shown here is 18 x 36 inches so this will fit a 36" or wider door.

## Materials

- 1/37th inch HDPE Panels (High Density Polyethylene)
  - These come in assorted colors and can be found at TAP Plastics and likely other places for ~\$9 for a 2 foot by 4 foot sheet.
- PPE - safety glasses, hearing protection, gloves
- Good scissors to cut the panel
- Sharpie pen
- Optional: 4 - ½ inch brass grommets and grommet kit
- Carabiners or Zip Ties

1. **What size door?** Determine panel size that works with your kennel door and trace to that size on the vinyl with Sharpie.
2. **Cut.** Using scissors, cut the panel out of the vinyl fabric.
3. **Round the edges.** An easy way to do this is by using a drinking cup to trace the rounded edges on the four corners.
4. **Poke 4 holes.** Poke holes in all four corners. A hole punch works well. (Optionally you can add brass grommets).
5. **Mount.** Use zip ties or carabiners to attach to kennel doors.



# Treat dispensing dog toy

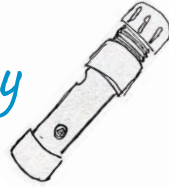

Cost: Less than \$10

Time: about 10 minutes

Skill Level: Easy

What do dogs love more than eating dinner? Getting food, enrichment, mental stimulation and play all at the same time! Not to mention, you are stretching out the fun (getting treats!) and delaying gratification.

## Materials

- PVC pipe (Your choice: 1", 1.5", 2")
- A pair of adapter/screw caps. The adapters and screw caps come in male or female. Either will work; just make sure you have a pair (i.e., a female adaptor with male screw cap, or a male adaptor with female screw cap).
- Note: We do not recommend ABS pipe (black pipe). It's more brittle than PVC.
- Slip cap - for the non-opening end
- PPE - safety glasses, hearing protection, gloves
- Saw to cut PVC – hand saw, miter saw, etc.
- Power drill
- Drill bit the size you want the food dispensing holes to be
- Clear PVC glue
- Small piece of sandpaper

Determine the size(s) of toy wanted and purchase the corresponding PVC pipe size.

1" for small pipe diameter toys

1.5" for medium diameter toys

2" for large pipe diameter toys

### Directions:

1. **Cut.** Cut the PVC pipe to desired length:

~ 4" for small pipe diameter toys (using 1" pipe)

~ 6" for medium diameter toys (using 1.5" pipe)

~ 8" for large pipe diameter toys (using 2" pipe)

dishwasher  
safe

## *Treat dispensing dog toy cont.*

2. **Glue.** Using PVC glue attach the slip cap to one end of the pipe.
3. **Glue some more.** Using PVC glue attach the male adapter to the other end.
4. **Screw.** Screw cap onto male adapter.
5. **Drill.** Drill holes into PVC pipe where desired. You could drill the holes first, but it's easier to see locations for drilling after the toy is made.
6. **Sand.** Remove the PVC burrs along the cut edges and sand the edges of the holes.
7. **Rinse it out.** Empty out PVC filings from drilling out the holes and wash toy.
8. **Add treats and give.** Give it to a pup and watch their tail wag.

Although these toys are very durable breakage may occur—always monitor before and after use.





## Dog retreat space

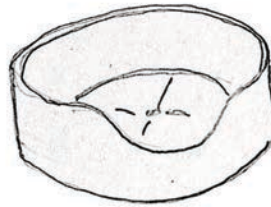

Time: 10-15 minutes

Cost: \$10 - 20

Skill level: Easy

Some of our new friends might benefit from feeling a bit more protected while we get to know each other. Converted storage containers make excellent retreat spaces for smaller dogs, and they are super durable. Bonus: they are usually easier to clean than a crate or carrier (but those will work too).

## Materials

- Plastic storage container
- Sharpie pen
- Skill saw
- Drill and drill bit (big enough to make a hole for the saw blade)

These can be made from storage containers of varying sizes. The one shown here was made with a recycle bin and was quite tall. The height allowed enough space for a hole to be cut and a small dog to enter and exit from one end of the container. The plastic of this bin is more firm than flexible, which helps maintain its shape.



With bins that are lower in height—where a pass-through would not fit—you could alternatively remove a scoop.

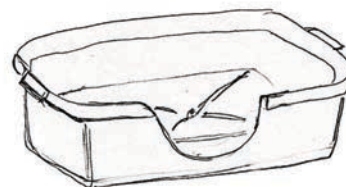

For larger dogs, drill, saw, and sand a hole into the side of a deck box and you'll have one happy Pete! Make sure to drill the hole higher than the bedding so blankets have a better chance of staying inside the container, dry and tidy.

*Pete*





# LOW STRESS DOG HOUSING DOUBLE COMPARTMENT

Main "LIVING" side ← "Bathroom" side + Space to Move about

GENERAL KENNEL DIMENSIONS

Kennel Wall Height	
Total	6'5"
Solid wall height	4'6" (+)
Kennel Width	4'-6"
Kennel Length	9'-12"

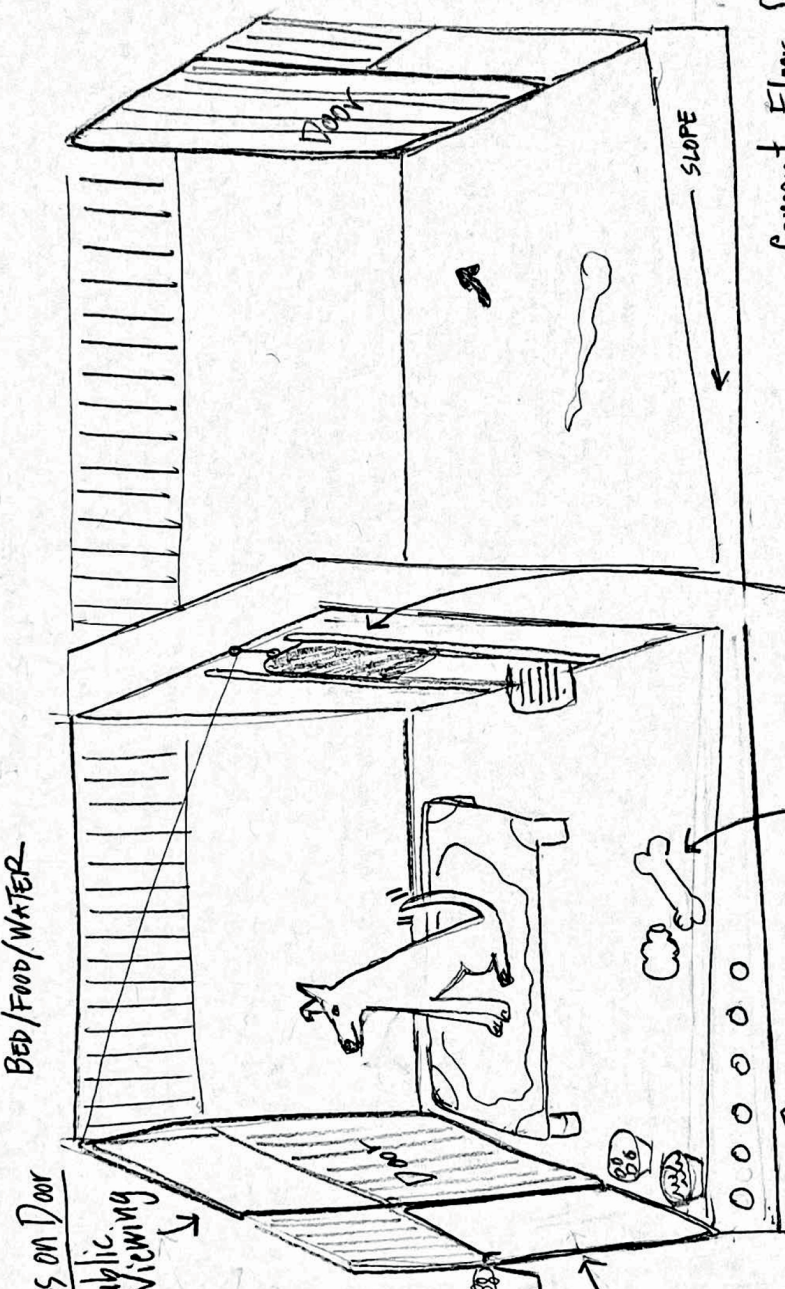

(Glass on Door)  
- Public Viewing

Open Bars  
- Interaction  
- Ventilation

Treat Bucket

Partial Visual Barrier  
- Visual choice  
- Retreat space  
- Can be made to be removable

Bed  
- With bedding  
- Can be double decker

Toys - Enrichment

Radiant Floor Heat  
- Comfort

Food/Water  
- Loose or attached to wall or door

Guillotine Door

- Does not span kennel width, thus providing retreat space  
- Ease of daily care  
- Staff safety

Cement Floor Slope To Drain

- Daily care + quicker dry times

Floor Covering

- Resinous Epoxy or Urethane for durability & cleanliness



**[WWW.SHELTERMEDICINE.COM](http://WWW.SHELTERMEDICINE.COM)**

---

KORET SHELTER MEDICINE PROGRAM